

Dimension

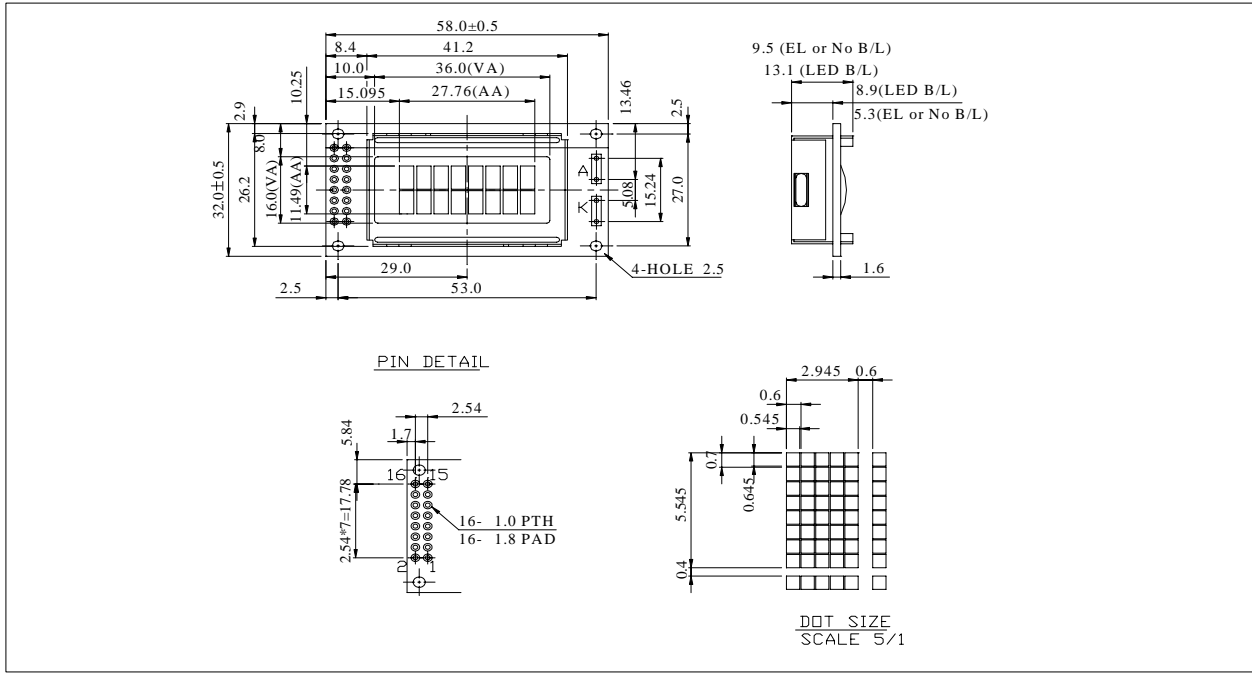

FEATURE

- 1. 5X8 dots character
- 2. Logic Power +5V(+3V) Input
- 3. Built in ST7066U Controller
- 4. 1/16 Duty

INTERFACE FUNCTIONS

Pin NO	Symbol	Function
1	VSS	0V
2	VDD	5V Logic
3	VO	LCD Operating Volt.
4	RS	Command/Data Select
5	RW	Read/Write
6	E	Enable
7	D0	Data Bus
8	D1	Data Bus
9	D2	Data Bus
10	D3	Data Bus
11	D4	Data Bus
12	D5	Data Bus
13	D6	Data Bus
14	D7	Data Bus
15	A	LED B/L V+
16	K	LED B/L V-

MECHANICAL DATA		
Item	Standard Value	Unit
Module Dimension	58.0 * 32.0	mm
Viewing Area	38.0 * 16.0	mm
Character Size	2.96 * 5.56	mm
Dot Size	0.56 * 0.66	mm

ABSOLUTE MAXIMUM RATING					
Item	Symbol	Standard Value			Unit
		min	typ	max	
Power Supply	VDD-VSS	2.5	5.0	5.5	V
Input Voltage	VIH	0.7Vdd	Vdd	Vdd+0.3	V

ELECTRONICAL CHARACTERISTICS						
Item	Symbol	Condition	Standard Value			Unit
			min	typ	max	
Input Voltage	VDD	25°C	2.7	5.0	5.3	V
Supply Current	IDD	25°C	0.8	1.0	1.2	mA
LCD Driving Voltage for	VDD-VO	-20°C	5.0	5.2	5.5	V
		0°C	4.5	4.7	5.0	
		25°C	4.1	4.3	4.5	
		50°C	3.8	4.0	4.2	
		70°C	3.6	3.8	4.0	
LED Forward Voltage	VF	25°C	4.0	4.2	4.5	V
LED Forward Current	IF	25°C	60	70	80	mA